

# ascott

Testing climate resistance to the limit

Corrosion Testing Equipment & Accessories

# The Ascott Story

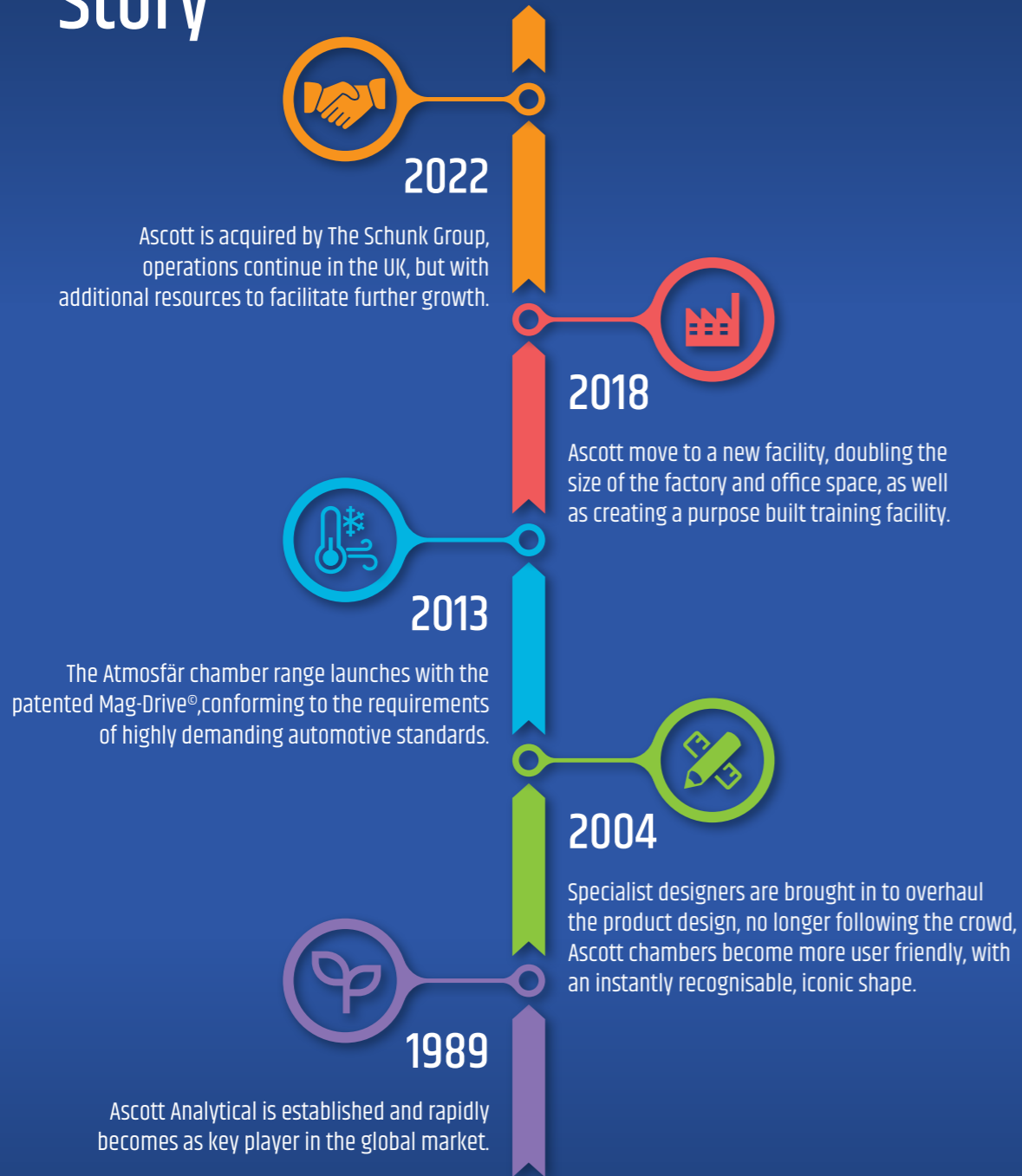

## Chamber selection made simple

Visit [www.ascott-analytical.com](http://www.ascott-analytical.com), to find a full list of test standards with suggested Ascott chambers for each test and also a chamber selector.

# At the forefront of chamber design

Ascott have been at the forefront of test chamber design for many years, and our latest product range embodies customer led innovation, blending performance with technical excellence.

The creation and control of corrosive climates has never been more demanding. The development of new materials and surface coatings, plus increasing user expectations gives rise to ever more rigorous testing. This is our forte. Let our expertise be your reassurance that choosing an Ascott chamber will ensure your testing is precise, compliant and repeatable.

## Salt Spray Corrosion Test Chambers



The salt spray test (also known as salt fog or salt mist) has been the bench-mark corrosion test in many industries for decades. With such a long history, so much test data and many

international test standards written around it, it remains a very popular choice as a relatively quick comparative test, to check whether or not test samples corrode in accordance with expectations. It's main application is therefore to audit the effectiveness of a production process.

## Atmosfär Corrosion Test Chambers



Atmosfär chambers have been designed specifically for fully automatic testing in accordance with highly demanding test profiles from the world's top automotive manufacturers.

The Atmosfär chamber is available in 2 sizes, 1300L or 2600L and is fitted with certain accessories to accommodate the test standards from FORD, VOLVO, SCANIA plus many others. There are different temperature ranges available, Lite from 20°C, or sub-zero from -20°C / -4°F or -40°C / -40°F.

## Cyclic Corrosion Test (CCT) Chambers



Cyclic Corrosion Testing is a means of recreating/accelerating a variety of corrosive climates, within the convenience of a test chamber. It is a useful test for predicting the life expectancy of

materials and components under simulated service life conditions. It has gained wide acceptance, particularly in the automotive industry, where many manufacturers have developed their own CCT standards.

## CorroFlex Chambers



CorroFlex corrosion test chambers offer the user flexibility in specifying the perfect size of chamber to suit their application. The width and depth dimensions are variable and can be selected in 0.5m increments.

## Ultra Compact Front Loading Chambers



The Ultra Compact front loading chamber range from Ascott is the perfect choice for customers who have limited floor area, and who only wish to test small or few components, in full compliance with international test standards.

## Free choice of canopy colour

All Ascott chambers are offered with a choice of canopy colour at no extra charge. Some of our standard colours are shown below, a full range of options is available on request.



## Kesternich SO2 Humidity Chamber



The Kesternich test is a common name for the corrosion test with sulfur dioxide (SO2) under general moisture condensation, whereby a specific volume of SO2 gas, usually 0.2L, 1L or 2L is introduced into the test chamber.

# Salt Spray Corrosion Test Chambers

To find the right chamber for your test requirements visit [www.ascott-analytical.com](http://www.ascott-analytical.com)

Ascott salt spray test chambers are offered in two model ranges: Standard & Premium.

## STANDARD

Standard models are designed for continuous salt spray tests, conducted at a single user-adjustable temperature, such as ASTM B117, ISO 9227, JIS Z 2371 etc. They may be used with pH neutral salt solutions (NSS) or test solutions acidified by the addition of Acetic Acid (ASS) or Cupric Acid (CASS).

## PREMIUM

Premium models can perform the same basic salt spray tests as Standard models, but in addition are equipped with extra features which enable them to undertake 'modified' tests such as ASTM G85. Here conventional salt spray is usually combined with one other climate, in a two-part cycle. For example: salt spray and condensation humidity (SWAAT) or salt spray and drying (PROHESION).



Premium 120 Ltr salt spray chamber



Standard 1000 Ltr salt spray chamber



Premium 2000 Ltr salt spray chamber

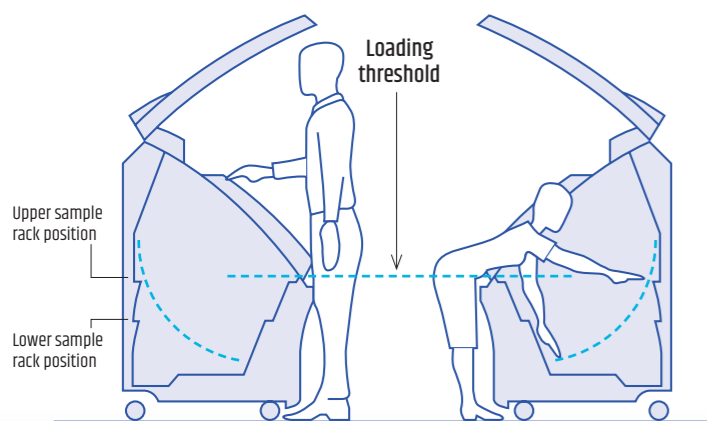

## FEATURES - Standard Models



- Full colour 3.5" touch screen controller with built in language selection.
- 'Easy Open' pneumatically operated canopy.
- Low loading threshold for loading and unloading.

- Dry seal gasket prevents wetting operator's clothes.
- Canopy colour choice free of charge.
- Interior viewing window.

- Purge of the cabinet interior with compressed air before the chamber is opened.
- Large capacity separate salt solution reservoir.

## FEATURES - Premium Models

Premium models have the same features as Standard models plus:

- Upgraded 7" Full colour Touch Screen Controller with built in language selection.
- RJ45 communications port for connection to a local area network (LAN) for logging and remote programming via a computer running optional Ascott software (ACC121).

- On/Off function with Temperature control for intermittent salt spray applications.
- Integrated titanium immersion heater to enable condensate humidity testing.
- Ambient drying function to open/close the canopy during a test, exposing the samples to ambient conditions in the room.



## PERFORMANCE

- **Salt Spray Mode**  
Temperature range - Adjustable from ambient to +50°C/+122°F.  
Salt spray fall-out rates - Adjustable from 0.5 to 2.0ml per 80cm<sup>2</sup> per hour.\*
- **Wetting mode (Premium chambers only)**  
Adjustable from ambient to +50°C/+122°F.
- **Forced Air Drying Mode (Premium chambers only)**  
Adjustable from ambient to +50°C/+122°F.

- **Controlled Temperature Only Mode (Premium chambers only)**  
Adjustable from ambient to 50°C/+122°F.
- **Ambient Air Drying Mode (Premium chambers only)**  
Chamber canopy can be programmed to open and close at any point during a test.



Ambient drying mode

\*Option ACC03 increases temperature range up to 60°C/140°F.

# Salt Spray Corrosion Specifications

| Standard salt spray chambers  |   | S120iS  | S450iS                | S1000iS                | S1300iS                | S2000iS                | S2600iS                |
|---|---|---|-----------------------|------------------------|------------------------|------------------------|------------------------|
| Premium salt spray chambers   |   | S120iP  | S450iP                | S1000iP                | S1300iP                | S2000iP                | S2600iP                |
| Chamber Capacity  |   | 120 Ltrs / 4.2 cu.ft  | 450 Ltrs / 15.8 cu.ft | 1000 Ltrs / 35.3 cu.ft | 1300 Ltrs / 45.9 cu.ft | 2000 Ltrs / 70.6 cu.ft | 2600 Ltrs / 91.8 cu.ft |
| Chamber Weight<br><small>(estimated, without optional accessories)</small>                            |   | 76 kg   | 190 kg                | 255 kg                 | 285 kg                 | 330 kg                 | 355 kg                 |
| Mounting format   |   | Bench top   | Floor standing        | Floor standing         | Floor standing         | Floor standing         | Floor standing         |
| Loading threshold   |   | 280mm/11"   | 800mm / 31.5"         | 800mm / 31.5"          | 800mm / 31.5"          | 800mm / 31.5"          | 800mm / 31.5"          |
| Chamber external dimensions   | W | 1315mm / 51.8"  | 1660mm / 65.4"        | 2025mm / 80.0"         | 2025mm / 80.0"         | 2885mm / 113.6"        | 2885mm / 113.6"        |
|   | D | 680mm / 26.8"   | 840mm / 33.1"         | 1145mm / 45.0"         | 1156mm / 45.5"         | 1145mm / 45.0"         | 1156mm / 45.5"         |
|   | H | 800mm / 31.5"   | 1510mm / 59.5"        | 1720mm / 67.5"         | 1906mm / 75.0"         | 1720mm / 67.5"         | 1906mm / 75.0"         |
| Chamber internal dimensions   | W | 715mm / 28.2"   | 1010mm / 39.5"        | 1300mm / 51.2"         | 1300mm / 51.2"         | 2160mm / 85.0"         | 2160mm / 85.0"         |
|   | D | 490mm / 19.3"   | 640mm / 25.0"         | 980mm / 38.5"          | 980mm / 38.5"          | 980mm / 38.5"          | 980mm / 38.5"          |
|   | H | 490mm / 19.3"   | 1140mm / 45.0"        | 1320mm / 52.0"         | 1528mm / 60.2"         | 1320mm / 52.0"         | 1528mm / 60.2"         |
| Salt solution reservoir<br><small>(external dimensions)</small>                                       | W | N/A   | 425mm / 16.7"         | 540mm / 21.2"          | 540mm / 21.2"          | 540mm / 21.2"          | 540mm / 21.2"          |
|   | D | N/A   | 425mm / 16.7"         | 540mm / 21.2"          | 540mm / 21.2"          | 540mm / 21.2"          | 540mm / 21.2"          |
|   | H | N/A   | 630mm / 24.8"         | 635mm / 25"            | 635mm / 25"            | 635mm / 25"            | 635mm / 25"            |
| Salt solution reservoir capacity<br><small>(for extra capacity, see optional accessory ACC59)</small> |   | N/A   | 73 Ltrs/19.3 US gal   | 90 Ltrs/23.7 US gal    | 90 Ltrs/23.7 US gal    | 90 Ltrs/23.7 US gal    | 90 Ltrs/23.7 US gal    |
| Chamber construction  |   | Glass reinforced plastic, Polypropylene & ABS parts   |                       |                        |                        |                        |                        |
| Colour  |   | 9 standard colours to choose from free of charge  |                       |                        |                        |                        |                        |
| Electricity supply<br>- Standard salt spray models<br>- Premium salt spray models                     |   | 1 phase   | 1 phase               | 1 phase                | 1 phase                | 1 phase*               | 1 phase*               |
|   |   | 1 phase   | 1 phase               | 1 phase                | 1 phase                | 3 phase                | 3 phase                |
|   |   | The voltage (VAC) and frequency (Hz) are dependent on country/region of installation (to be confirmed at time of ordering)  |                       |                        |                        |                        |                        |
| Water   |   | The air saturator, humidity generator and salt solution reservoir all require separate connections to a continuous, pressurized deionized/distilled water supply of 2.5 to 5 bar (36-73psi) |                       |                        |                        |                        |                        |
| Air   |   | Clean dry & oil free, 4.0 to 6.0 bar (58-87psi) with 240 Ltrs (8.5cu.ft) per minute flow  |                       |                        |                        |                        |                        |
| Exhaust   |   | 3m (10ft) exhaust pipe is required which should be terminated outside building (see accessory ACC58)  |                       |                        |                        |                        |                        |
| Drain   |   | 3m (10ft) drain pipe is required which should be terminated into floor level drain (see accessory ACC58)  |                       |                        |                        |                        |                        |
| Operating environment conditions  |   | Indoors, with ambient maintained at +18 to +23°C (+64 to 73°F), 85% max RH (non-condensing)   |                       |                        |                        |                        |                        |

\*Will be 3 phase electrical supply, if ordered to operate on 110V

✓ Inspected    ✓ Tested  
✓ Measured    ✓ Approved



For all test equipment and consumable items, please visit;

[www.ascottshop.com](http://www.ascottshop.com)

Everything you need, from one trusted supplier!

# Cyclic Corrosion Test Chambers (CCT)

To find the right chamber for your test requirements visit [www.ascott-analytical.com](http://www.ascott-analytical.com)

Ascott CCT chambers are designed to be flexible enough to comply with as many different CCT specifications as possible.

As standard they come with the ability to create 6 distinct climates:

- Salt spray
- Condensation humidity (wetting)
- Forced air drying
- Temperature Only
- Ambient drying
- Controlled humidity

These may be programmed to occur in any sequence and be repeated automatically. A wide range of optional accessories enable additional climates to be added to further extend the number of climates and conditions that can be created.



1000 Ltr CCT chamber

## FEATURES

- Low loading threshold for loading and unloading.

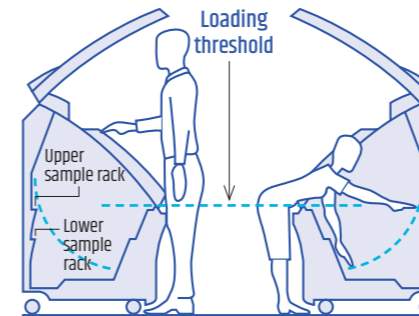

- 'Easy Open' pneumatically operated canopy.
- Dry seal gasket prevents wetting operator's clothes, etc.

- Interior viewing window (unless refrigeration option is supplied).
- Canopy colour choice free of charge.
- Purge of the cabinet interior with fresh air before the chamber is opened.
- Large capacity separate salt solution reservoir.

- Ambient drying function to open/close the canopy during a test, exposing the samples to ambient conditions in the room.
- RJ45 communications port for connection to a local area network (LAN) for logging and remote programming via a computer running optional Ascott software (ACC121).



- 7" Full colour Touch Screen Controller with built in language selection and large capacity memory.
- On/off function with temperature control for intermittent salt spray applications.
- Temperature and humidity monitoring in SCADA using OPC-UA.

## PERFORMANCE

- **Wetting Mode**  
 Temperature range - Adjustable from ambient to +70°C/+158°F.  
 Humidity range - Fixed at 95% - 100% RH.
- **Salt Spray Mode**  
 Temperature range - Adjustable from ambient to +60°C/+140°F.  
 Salt spray fall-out rates - Adjustable from 0.5 to 2ml per 80cm<sup>2</sup> per hour.\*
- **Forced Air Drying Mode**  
 Temperature range - Adjustable from ambient to +70°C/+158°F.\*
- **Controlled Humidity Mode**  
 Temperature/humidity range - See graph.
- **Controlled Temperature Only Mode**  
 Adjustable from ambient to +60°C/+140°F.
- **Ambient Air Drying Mode**  
 Chamber canopy can be programmed to open and close at any point during a test

\*Option ACC47/8-13 increases the maximum temperature to +80°C/+176°F.



450 Ltr CCT chamber

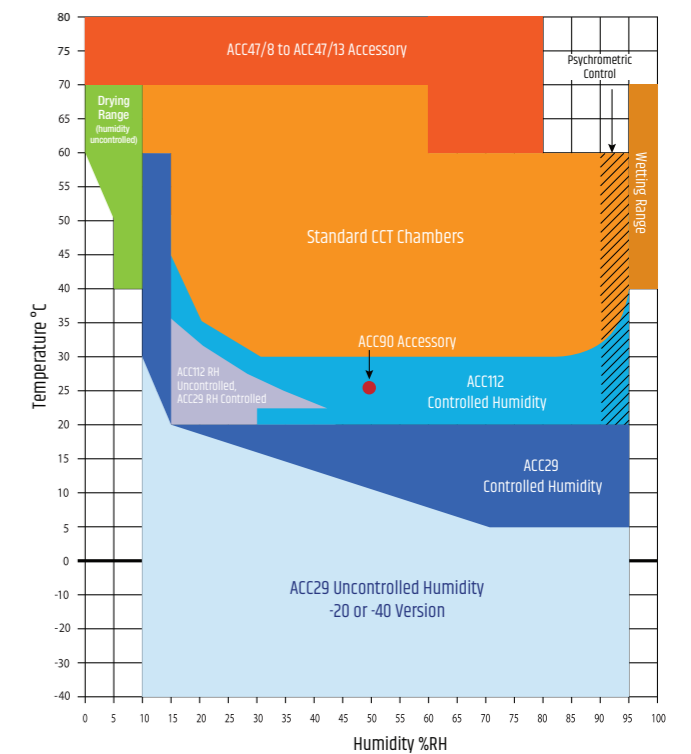
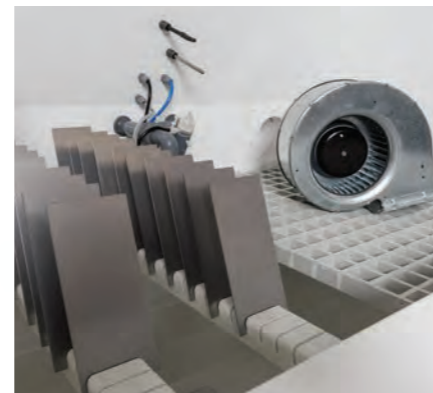

# Cyclic Corrosion Specifications

| Cyclic corrosion test chambers  |             | CC450iP   | CC1000iP   | CC1300iP   | CC2000iP  | CC2600iP  |
|---|-------------|---|--|--|---|---|
| Chamber Capacity  |             | 450 Ltrs / 15.8 cu.ft   | 1000 Ltrs / 35.3 cu.ft                             | 1300 Ltrs / 45.9 cu.ft                             | 2000 Ltrs / 70.6 cu.ft                              | 2600 Ltrs / 91.8 cu.ft                              |
| Chamber Weight (estimated, without optional accessories)                            |             | 190 kg  | 255 kg   | 285 kg   | 330 kg  | 355 kg  |
| Mounting format   |             | Floor standing  | Floor standing                                     | Floor standing                                     | Floor standing                                      | Floor standing                                      |
| Loading threshold   |             | 800mm / 31.5"   | 800mm / 31.5"                                      | 800mm / 31.5"                                      | 800mm / 31.5"                                       | 800mm / 31.5"                                       |
| Chamber external dimensions   | W<br>D<br>H | 1660mm / 65.4"<br>840mm / 33.1"<br>1510mm / 59.5"   | 2025mm / 80.0"<br>1145mm / 45.0"<br>1720mm / 67.5" | 2025mm / 80.0"<br>1156mm / 45.5"<br>1906mm / 75.0" | 2885mm / 113.6"<br>1145mm / 45.5"<br>1720mm / 67.5" | 2885mm / 113.6"<br>1156mm / 45.5"<br>1906mm / 75.0" |
| Chamber internal dimensions   | W<br>D<br>H | 1010mm / 39.5"<br>640mm / 25.0"<br>1140mm / 45.0"   | 1300mm / 51.2"<br>980mm / 38.5"<br>1320mm / 52.0"  | 1300mm / 51.2"<br>980mm / 38.5"<br>1528mm / 60.2"  | 2160mm / 85.0"<br>980mm / 38.5"<br>1320mm / 52.0"   | 2160mm / 85.0"<br>980mm / 38.5"<br>1528mm / 60.2"   |
| Salt solution reservoir (external dimensions)                                       | W<br>D<br>H | 425mm / 16.7"<br>425mm / 16.7"<br>630mm / 24.8"   | 540mm / 21.2"<br>540mm / 21.2"<br>635mm / 25"      | 540mm / 21.2"<br>540mm / 21.2"<br>635mm / 25"      | 540mm / 21.2"<br>540mm / 21.2"<br>635mm / 25"       | 540mm / 21.2"<br>540mm / 21.2"<br>635mm / 25"       |
| Salt solution reservoir capacity (for extra capacity, see optional accessory ACC59) |             | 73 Ltrs/19.3 US gal   | 90 Ltrs/23.7 US gal                                | 90 Ltrs/23.7 US gal                                | 90 Ltrs/23.7 US gal                                 | 90 Ltrs/23.7 US gal                                 |
| Chamber construction  |             | Glass reinforced plastic, Polypropylene & ABS parts   |  |  |   |   |
| Colour  |             | 9 standard colours to choose from free of charge  |  |  |   |   |
| Electricity supply - CCT models   |             | 3 phase   | 3 phase  | 3 phase  | 3 phase   | 3 phase   |
|   |             | The voltage (VAC) and frequency (Hz) are dependent on country/region of installation (to be confirmed at time of ordering)  |  |  |   |   |
| Water   |             | Deionized/distilled for topping up air saturator and making salt solution. Air saturator requires a continuous water connection 2.5-5.0 bar (36-72 psi). If ACC42 is ordered the continuous water supply must be pressurised 4.0 - 5.0 bar (58-72psi). If air saturator is topped up manually option ACC66 must be ordered. |  |  |   |   |
| Air   |             | Clean dry & oil free, 4.0 to 6.0 bar (58-87psi) with 240 Ltrs (8.5cu.ft) per minute flow  |  |  |   |   |
| Exhaust   |             | 3m (10ft) exhaust pipe is required which should be terminated outside building (see accessory ACC58)  |  |  |   |   |
| Drain   |             | 3m (10ft) drain pipe is required which should be terminated into floor level drain (see accessory ACC58)  |  |  |   |   |
| Operating environment conditions  |             | Indoors, with ambient maintained at +18 to +23°C (+64 to 73°F), 85% max RH (non-condensing)   |  |  |   |   |

# Cyclic Corrosion Test Profiles

To find the right chamber for your test requirements visit [www.ascott-analytical.com](http://www.ascott-analytical.com)

## CCT-1 / JASO M 609 / JASO M 610

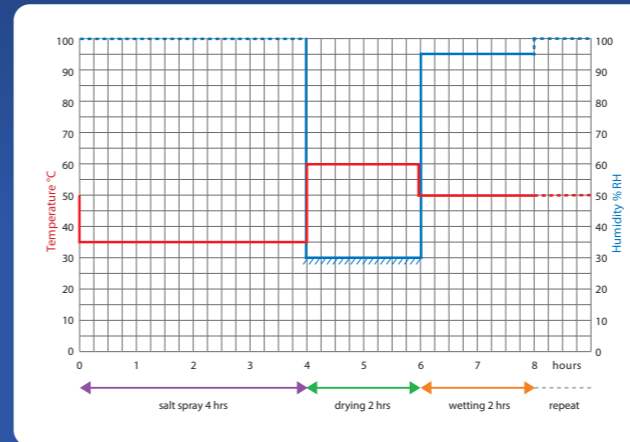

## P-VW 1200, 1209 & 1210 (VW/Audi)

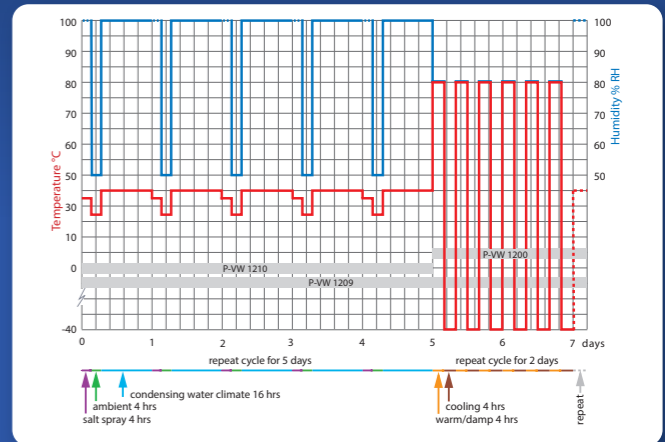

## CETP 00.00-L-467 (Ford/Volvo ACT-2, VCS1027,1449, TPJLR-52-265)

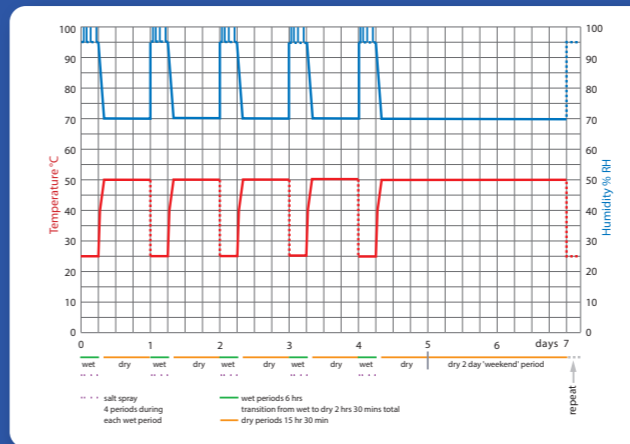

## VDA 233-102

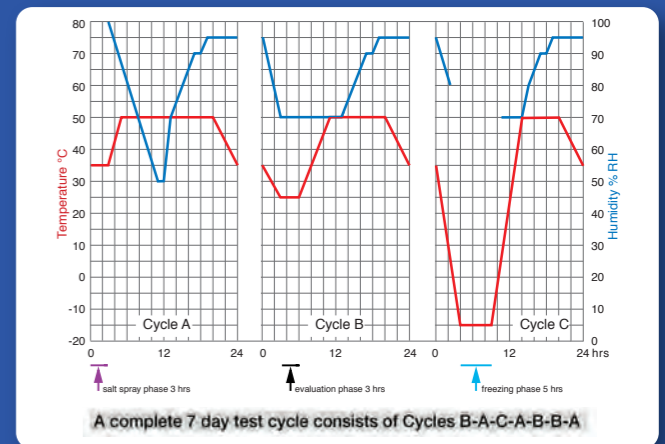

## D17 2028 (Renault ECC1)

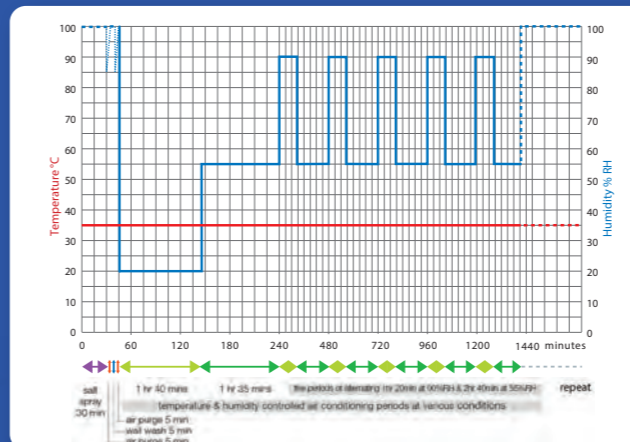

## 5100Z-SG0-A000 (Honda)

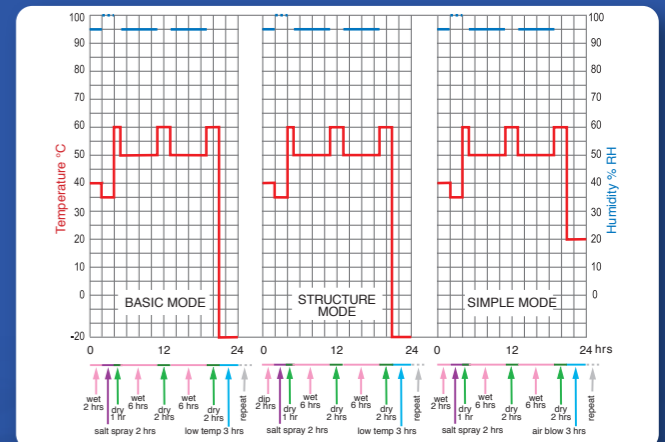

# Ultra Compact Front Loading Test Chambers

The Ultra Compact front loading chamber range from ascott is available in two sizes, 300L and 400L, and is the perfect choice for customers who have limited floor area, and who only wish to test small or few components, in full compliance with international test standards.



Standard Salt Spray Chamber

The standard salt spray chamber is designed for continuous salt spray tests, such as ASTM B117, ISO 9227, JIS Z 2371 etc.

It can also be used with pH neutral salt solutions (NSS) or test solutions acidified by the addition of Acetic Acid (ASS) or Cupric Acid (CASS).



Premium Salt Spray Chamber

The Premium salt spray chamber can perform the same basic salt spray tests as Standard models, but in addition it is equipped with extra features which enable them to undertake 'modified' tests such as ASTM G85 where salt spray is usually combined with one other function, in a two-part cycle. For example: salt spray and condensation humidity, or salt spray and drying.

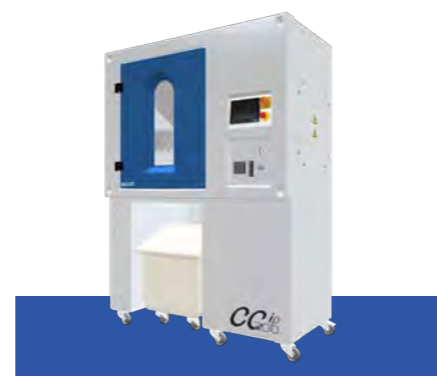

Cyclic Corrosion Test Chamber

The Cyclic corrosion chamber is designed to be flexible enough to comply with as many different CCT specifications as possible.

The CCIP can cycle between salt spray, wetting, drying and controlled humidity in any sequence for any period of time.

## Key Features to all models...

- Front loading system for ease of loading test samples in a wide range of shapes and sizes.
- Chamber designed with angled interior roof to avoid condensation droplets falling onto samples below.
- Pneumatically operated door for ease of opening and closing.
- Touch screen available in multiple languages for ease of understanding and use.
- High strength GRP front door available in 9 standard colours with windows for viewing samples during testing.
- Exterior shell is fully resistant to corrosion.
- 115L / 30US Gallon portable salt solution tank with wheels, for ease of access to a water source, and an integral drain for ease of cleaning.

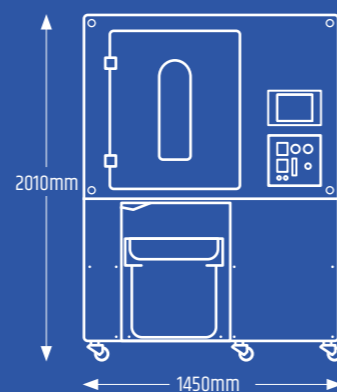

## FEATURES - Standard Models

- Full colour 3.5" touch screen controller with built in language selection.
- 'Easy Open' pneumatically operated canopy.
- Low loading threshold for loading and unloading.
- Dry seal gasket prevents wetting operator's clothes.
- Canopy colour choice free of charge.
- Interior viewing window.
- Purge of the cabinet interior with compressed air before the chamber is opened.
- Large capacity separate salt solution reservoir.



## FEATURES - Premium Models

Premium models have the same features as Standard models plus:



- Upgraded 7" Full colour Touch Screen Controller with built in language selection and large capacity memory.

- RJ45 communications port enabling the chamber to be wire or wirelessly connected to a local area network (LAN) for logging and remote programming via a computer running optional software( Ref ACC121).
- Integrated titanium immersion heater to enable condensate humidity testing.
- Ambient drying function to open/close the canopy during a test, exposing the samples to ambient conditions in the room.
- On/off function with Temperature control for intermittent salt spray applications.



## FEATURES - Cyclic Corrosion Models

Cyclic Corrosion models have the same features as Standard & Premium Salt Spray chambers plus:

- As standard the chamber comes with the ability to create 6 distinct climates:
  - Salt spray
  - Condensation humidity (wetting)
  - Forced air drying
  - Temperature only
  - Ambient air drying
  - Controlled humidity
- User adjustable Controlled Humidity for atmospheres up to 94% RH, at temperature controlled atmospheres from ambient to +60°C/+140°F (see graph on page 14).
- Temperature and Humidity monitoring in SCADA using OPC-UA.
- Interior Viewing Window (unless refrigeration ACC29/31 option is supplied).
- Wide range of optional accessories available to further extend the chambers test conditions.

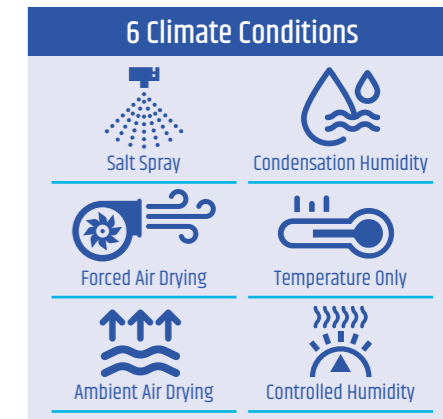

# Ultra Compact Specifications

| Standard salt spray chambers  | S300IS   | S400IS   |
|---|--|--|
| Chamber Capacity  | 300 Ltrs / 10.5cu.ft   | 400 Ltrs / 15.8 cu.ft                              |
| Chamber Weight (estimated, without optional accessories)                            | 190 kg   | 220 kg   |
| Mounting format   | Floor standing   | Floor standing                                     |
| Loading threshold   | 1100mm / 43.3"   | 1100mm / 43.3"                                     |
| Chamber external dimensions   | W 1450mm / 57"<br>D 769mm / 30"<br>H 2010mm / 80"  | W 2200mm / 87"<br>D 1030mm / 40"<br>H 2010mm / 80" |
| Chamber internal dimensions   | W 855mm / 34"<br>D 601mm / 24"<br>H 711mm / 27"<br>reducing to 407mm / 16"   | W 1010mm / 39"<br>D 640mm / 25"<br>H 1140mm / 45"  |
| Salt solution reservoir (external dimensions)                                       | W 560mm / 22"<br>D 620mm / 24"<br>H 675mm / 26"  | W 560mm / 22"<br>D 620mm / 24"<br>H 675mm / 26"    |
| Salt solution reservoir capacity (for extra capacity, see optional accessory ACC59) | 115L / 30 US gal   | 115L / 30 US gal                                   |
| Chamber construction  | Glass reinforced plastic, Polypropylene & ABS parts  |  |
| Colour  | 9 standard colours to choose from free of charge   |  |
| <b>Electricity supply</b>   | - Standard salt spray models 1 phase<br>- Premium salt spray models 1 phase<br>- CCT models 3 phase  |  |
| <b>Water</b>  | Deionized/distilled for topping up air saturator and making salt solution. Air saturator requires a continuous water connection 2.5-5.0 bar (36-72 psi). If ACC42 is ordered the continuous water supply must be pressurised 4.0 - 5.0 bar (58-72 psi). If air saturator is topped up manually option ACC66 must be ordered. |  |
| <b>Air</b>  | Clean dry & oil free, 4.0 to 6.0 bar (58-87psi) with 240 Ltrs (8.5cu.ft) per minute flow   |  |
| <b>Exhaust</b>  | 3m (10ft) exhaust pipe is required which should be terminated outside building (see accessory ACC58)   |  |
| <b>Drain</b>  | 3m (10ft) drain pipe required which should be terminated into floor level drain (see accessory ACC5B)  |  |
| <b>Operating environment conditions</b>   | Indoors, with ambient maintained at +18 to +23°C (+64 to 73°F), 85% max RH (non-condensing)  |  |

## Test Chamber Performance

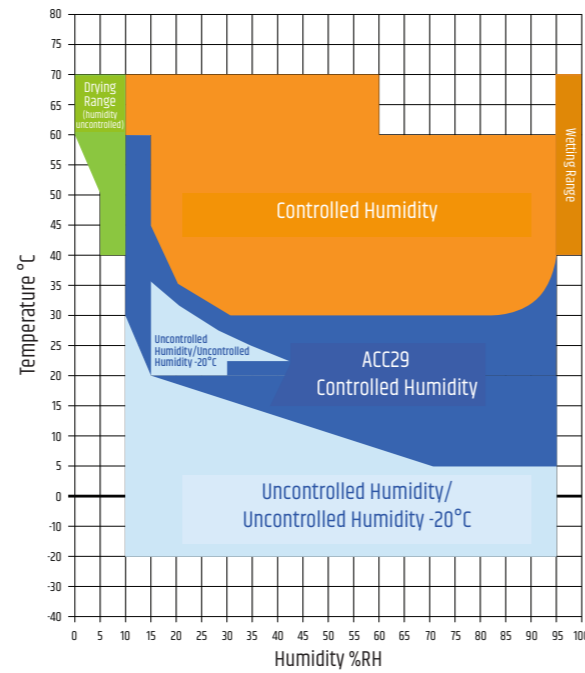

## Small Compact Footprint

300L - 1450 x 769 x 2010mm / 57 x 30 x 80"

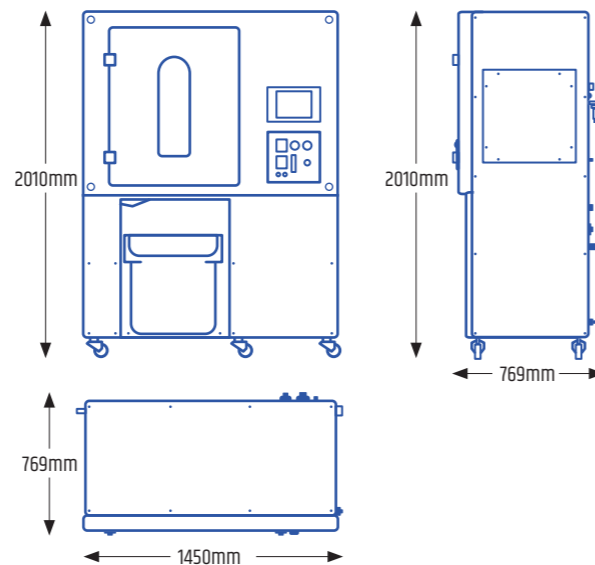

# Corro-Salt

## Salt for salt spray testing

To find the right chamber for your test requirements visit [www.ascott-analytical.com](http://www.ascott-analytical.com)

- Highest purity salt for fully compliant testing
- For all salt spray testing including the stringent ASTM B117
- Available in 25Kg (55lb) drums or bags
- Drums are with a scoop to maintain purity when handling



Despite the fact that salt is a commonly occurring compound, pure sodium chloride (NaCl) is much more difficult to come by. Because of its hygroscopic nature, which tends to make salt coagulate and solidify, most granulated salt has anti-caking agents added. However, the addition of these agents is prohibited by most salt spray test standards.

For example, the world's most popular salt spray test standard; ASTM B117, prohibits the addition of anticaking agents, and also limits other impurities, as follows: total impurities < 0.3%, halides excluding chloride < 0.1%, copper < 0.3ppm - so the salt must be very pure indeed, with the limit for copper in particular set at an extremely low level. Other national and international test standards for corrosion testing are similarly demanding in their specifications. To ensure compliance with the highest standards, Ascott has had Corro-Salt independently analysed by an UKAS\* accredited laboratory.

\*UKAS = United Kingdom Accreditation Service.

### Specification - Typical analysis

|                  |           |
|------------------|-----------|
| Total impurities | < 0.1 %   |
| Bromide          | < 0.01 %  |
| Fluoride         | < 0.01 %  |
| Iodide           | < 0.01 %  |
| Copper           | < 0.3 ppm |

| Code    | Description                   |
|---------|-------------------------------|
| SALA530 | 25 kg drum of salt with scoop |
| SALA500 | 25 kg bag of salt             |

(Bulk quantities available upon request.)

Order now at [www.ascottshop.com](http://www.ascottshop.com) | E: [sales@ascott-analytical.com](mailto:sales@ascott-analytical.com) | T: +44 (0) 1827 318040

# Atmosfär Test Chambers

Atmosfär chambers have been specifically designed for fully automatic testing in accordance with highly demanding laboratory-accelerated corrosion tests which have become increasingly popular in some sectors of the automotive industry.

These tests are cyclic in nature and comprise of exposure under controlled and varying conditions of temperature and humidity, with intermittent spraying of a salt solution directly on to the samples under test, from a high level swaying spray bar.

**Two model sizes:**

- 1300 Ltr (45.9 cu ft)
- 2600 Ltr (91.8 cu ft)

**Extensive optional testing facilities:**

Extensive range optional testing facilities, such as SO<sub>2</sub> gas dosing and liquid immersion.



**Fully automatic laboratory-accelerated atmospheric corrosion testing to;**

- ISO 16701
- Volvo STD 1027,1375
- Ford CETP 00.00-L-467
- GMW14872
- Volvo VCS 1027,149 (ACT-1)
- CCT1 & CCT2
- Volvo VCS 1027,1449 (ACT-2)
- DIN 55635
- Volvo STD 423-0014
- Scania STD4319
- TPJLR.52.265
- VDA 233-102

**All Ascott Atmosfär Corrosion Test chambers feature:**

- Patented oscillating spray bar with magnetically coupled drive system, for compliance with the most demanding automotive test standards.
- Integrated air conditioning unit, to achieve demanding temperature and humidity combinations.
- Psychrometric humidity capability for control of humidity @ >94% RH.



**MAG-DRIVE**  
Patented technology of Ascott Analytical Equipment Ltd

**Atmosfär Innovative design** - the oscillating spray bar and air delivery system are quickly and easily removed to enable the chamber to comply with other CCT test standards.



1. The air system collection tube is easily removed.



2. The combined air dispersal and oscillating spray bar unit simply lifts out.



3. The Atmosfär chamber is now ready for other types of corrosion test.



To find the right chamber for your test requirements visit [www.ascott-analytical.com](http://www.ascott-analytical.com)

**KEY FEATURES**

- Ergonomic design low loading threshold for easy loading and unloading.
- Canopy colour choice free of charge.
- Interior viewing window (unless refrigeration option is supplied).
- Purge of the cabinet interior with compressed air before the chamber is opened.
- On/off function with Temperature control for intermittent salt spray applications.
- RJ45 communications port for connection to a local area network (LAN) for logging and remote programming via a computer running optional Ascott software (ACC121).
- Ambient drying function to open/close the canopy during a test, exposing the samples to ambient conditions in the room.
- 7" Full colour Touch Screen Controller with built in language selection and large capacity memory.

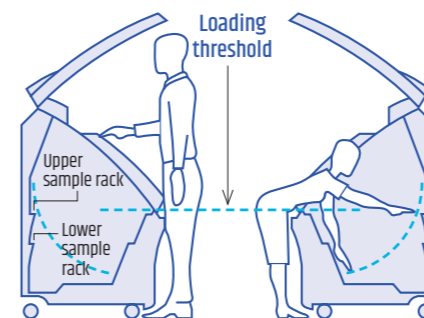

- 'Easy Open' pneumatically operated canopy.
- Dry seal gasket prevents wetting operator's clothes.
- Large capacity separate salt solution reservoir.



**PERFORMANCE**

- **Wetting Mode**  
Temperature range - Adjustable from ambient to +70°C/+158°F.  
Humidity range - Fixed at 95% - 100% RH.
- **Oscillating Salt Spray Mode**  
Temperature range - Adjustable from ambient to +60°C/+140°F.  
Salt spray fall-out rates - Adjustable from 5 to 10 Ltrs/m<sup>2</sup> per hour.
- **Conventional Salt Spray Mode**  
Temperature range - Adjustable from ambient to +60°C/+140°F.  
Salt spray fall-out rates - Adjustable from 0.5 to 2ml per 80cm<sup>2</sup> per hour.\*
- **Forced Air Drying Mode**  
Temperature range - Adjustable from ambient to +70°C/+158°F.
- **Climatic Mode**  
Temperature/humidity range - See graph.
- **Controlled Temperature Only Mode**  
Adjustable from ambient to 60°C/+140°F.
- **Ambient Air Drying Mode**  
Chamber canopy can be programmed to open and close at any point during a test.

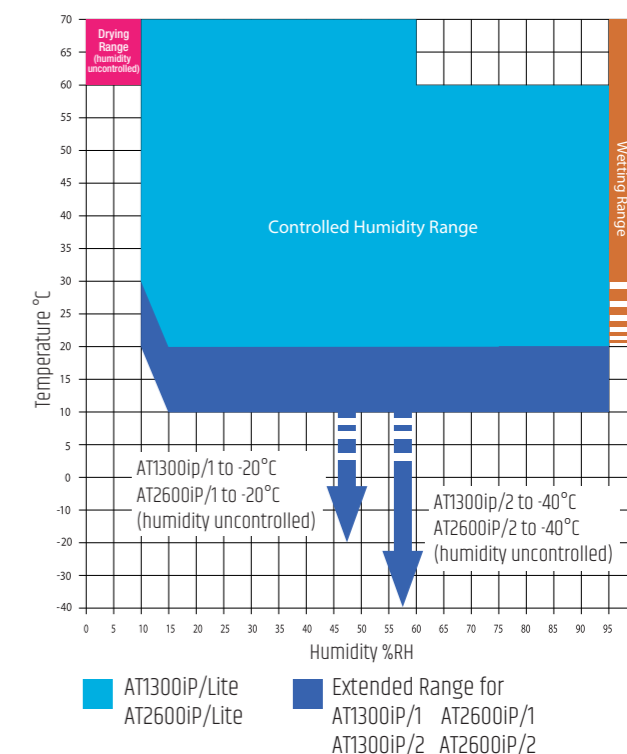

\*Option ACC25 or ACC01 increases the fallout rate up to 5.5ml per 80cm<sup>2</sup> per hour.

Ascott chambers require ambient conditions of 18°C to 23°C to perform in line with standards requirements.

# Atmosfär Specifications

| Atmosfär test chambers   |   | AT1300iP/Lite  | AT1300iP/1  | AT1300iP/2  | AT2600iP/Lite                 | AT2600iP/1  | AT2600iP/2  |
|--|---|--|---|---|-------------------------------|---|---|
| Minimum controlled temperature   |   | 20°C/68°F  | -20°C / -4°F  | -40°C / -40°F   | 20°C/68°F                     | -20°C / -4°F  | -40°C / -40°F   |
| Chamber capacity   |   | 1300 Ltrs / 45.9 cu.ft   | 1300 Ltrs / 45.9 cu.ft  | 1300 Ltrs / 45.9 cu.ft  | 2600 Ltrs / 91.8 cu.ft        | 2600 Ltrs / 91.8 cu.ft  | 2600 Ltrs / 91.8 cu.ft  |
| Chamber weight   |   | 340 kg   | 340 kg  | 340 kg  | 440 kg                        | 440 kg  | 440 kg  |
| Mounting format  |   | Floor standing   | Floor standing  | Floor standing  | Floor standing                | Floor standing  | Floor standing  |
| Loading threshold  |   | 800mm / 31.5"  | 800mm / 31.5"   | 800mm / 31.5"   | 800mm / 31.5"                 | 800mm / 31.5"   | 800mm / 31.5"   |
| Chamber external dimensions  | W | 2025mm / 80.0"   | 2025mm / 80.0"  | 2025mm / 80.0"  | 2885mm / 113.6"               | 2885mm / 113.6"   | 2885mm / 113.6"   |
|  | D | 1316mm / 51.8"   | 1316mm / 51.8"  | 1316mm / 51.8"  | 1316mm / 51.8"                | 1316mm / 51.8"  | 1316mm / 51.8"  |
|  | H | 1965mm / 77.4"   | 1965mm / 77.4"  | 1965mm / 77.4"  | 1965mm / 77.4"                | 1965mm / 77.4"  | 1965mm / 77.4"  |
| Chamber internal dimensions  | W | 1300mm / 51.2"   | 1300mm / 51.2"  | 1300mm / 51.2"  | 2160mm / 85.0"                | 2160mm / 85.0"  | 2160mm / 85.0"  |
|  | D | 980mm / 38.5"  | 980mm / 38.5"   | 980mm / 38.5"   | 980mm / 38.5"                 | 980mm / 38.5"   | 980mm / 38.5"   |
|  | H | 1500mm / 59.0"   | 1500mm / 59.0"  | 1500mm / 59.0"  | 1500mm / 59.0"                | 1500mm / 59.0"  | 1500mm / 59.0"  |
| Refrigeration unit   | W | 650mm / 25.6"  | 1125mm / 44.3"  | 1125mm / 44.3"  | 650mm / 25.6"                 | 1125mm / 44.3"  | 1125mm / 44.3"  |
|  | D | 1350mm / 53.1"   | 1354mm / 53.3"  | 1354mm / 53.3"  | 1350mm / 53.1"                | 1354mm / 53.3"  | 1354mm / 53.3"  |
|  | H | 1070mm / 42.1"   | 1624mm / 63.9"  | 1624mm / 63.9"  | 1070mm / 42.1"                | 1624mm / 63.9"  | 1624mm / 63.9"  |
| Salt solution reservoir<br>90 Ltrs/23 US gal   | W | 540mm / 21.2"  | 540mm / 21.2"   | 540mm / 21.2"   | 540mm / 21.2"                 | 540mm / 21.2"   | 540mm / 21.2"   |
|  | D | 540mm / 21.2"  | 540mm / 21.2"   | 540mm / 21.2"   | 540mm / 21.2"                 | 540mm / 21.2"   | 540mm / 21.2"   |
|  | H | 635mm / 25"  | 635mm / 25"   | 635mm / 25"   | 635mm / 25"                   | 635mm / 25"   | 635mm / 25"   |
| Separate unit, one supplied to deliver salt water to the conventional salt spray atomizer                                      |   |  |   |   |                               |   |   |
| Salt solution reservoir<br>160 Ltrs/42.2 US gal  | W | 840mm / 34.0"  | 840mm / 34.0"   | 840mm / 34.0"   | 840mm / 34.0"                 | 840mm / 34.0"   | 840mm / 34.0"   |
|  | D | 500mm / 19.7"  | 500mm / 19.7"   | 500mm / 19.7"   | 500mm / 19.7"                 | 500mm / 19.7"   | 500mm / 19.7"   |
|  | H | 790mm / 31.1"  | 790mm / 31.1"   | 790mm / 31.1"   | 790mm / 31.1"                 | 790mm / 31.1"   | 790mm / 31.1"   |
| Separate unit, one supplied to deliver salt water to the oscillating spray bar   |   |  |   |   |                               |   |   |
| Chamber construction   |   | Glass reinforced plastic, Polypropylene & ABS parts  |   |   |                               |   |   |
| Colour   |   | 9 standard colours to choose from free of charge   |   |   |                               |   |   |
| Electricity supply   |   | One 3-phase electrical supply  | Two 3-phase electrical supplies are required (one for the chamber and one for the separate air conditioning unit) | Two 3-phase electrical supplies are required (one for the chamber and one for the separate air conditioning unit) | One 3-phase electrical supply | Two 3-phase electrical supplies are required (one for the chamber and one for the separate air conditioning unit) | Two 3-phase electrical supplies are required (one for the chamber and one for the separate air conditioning unit) |
| The voltage (VAC) and frequency (Hz) are dependent on country/region of installation (to be confirmed at the time of ordering) |   |  |   |   |                               |   |   |
| Air  |   | Clean dry & oil free compressed air, 4.0 to 6.0 bar (58-87psi) with 240 Ltrs (8.5cu.ft) per minute flow. Two separate supplies are required, one for the chamber and one for the separate refrigeration unit |   |   |                               |   |   |
| Exhaust  |   | 3m (10ft) exhaust pipe is required which should be terminated outside building (see accessory ACC58)   |   |   |                               |   |   |
| Drain  |   | 3m (10ft) drain pipe is required which should be terminated into floor level drain (see accessory ACC58)   |   |   |                               |   |   |
| Operating environment conditions   |   | Indoors, with ambient maintained at +18 to +23°C (+64 to 73°F), 85% max RH (non-condensing)  |   |   |                               |   |   |

# For everything you need to know

visit [www.ascott-analytical.com](http://www.ascott-analytical.com)

Find the exact chamber for your requirements

- Select a standard to test to, and find the perfect Ascott chamber



[www.ascott-analytical.com](http://www.ascott-analytical.com)

Find details of the latest corrosion test standards

- Summary details of well over a 100 key corrosion test standards
- Visit [www.ascott-analytical.com/](http://www.ascott-analytical.com/) ...and select the standard from the drop down menu

Watch Ascott instruction and tutorial videos

- Chamber key features
- Optional accessories

[www.ascott-analytical.com/view-ascott-videos/](http://www.ascott-analytical.com/view-ascott-videos/)

Read the latest Ascott news stories

- New products
- Product improvements
- Company stories

[www.ascott-analytical.com/news/](http://www.ascott-analytical.com/news/)

Learn how Ascott corrosion chambers work

- Salt Spray Test Chambers
- Cyclic Corrosion Test Chambers
- Atmosfär Test Chambers

[www.ascott-analytical.com/how-chambers-work/](http://www.ascott-analytical.com/how-chambers-work/)



...and much, much more

# Atmosfär Premium Test Chambers



To find the right chamber for your test requirements visit [www.ascott-analytical.com](http://www.ascott-analytical.com)

The Premium version of the Atmosfär Range offers the most extensive and flexible Test Standard scope solution on the market place with increased temperature ranges and faster temperature transition times.

All Ascott Atmosfär Premium Test Chambers feature:

- Oscillating spray bar with magnetically coupled drive system, for compliance with the most demanding automotive test standards.
- Integrated air conditioning unit, to achieve demanding temperature and humidity combinations.
- Psychrometric humidity capability for control of humidity @ >94% RH.
- Temperature and humidity Logging Software.
- 110mm Entry Port.
- Digital Salt Solution Consumption Indicator.
- Additional Salt Solution Atomizers for standards such as VDA 233-102, RNES-G-00005, Renault ECC1, SAE J etc.
- Temperature and Humidity Control @ 80°C/176°F and 80% RH.
- Rapid ramping from 35°C/95°F to 70°C/158°F in 15 minutes.



Example of dual atomiser system on 2600L Atmosfär Premium Chamber



1300L Atmosfär Premium Chamber

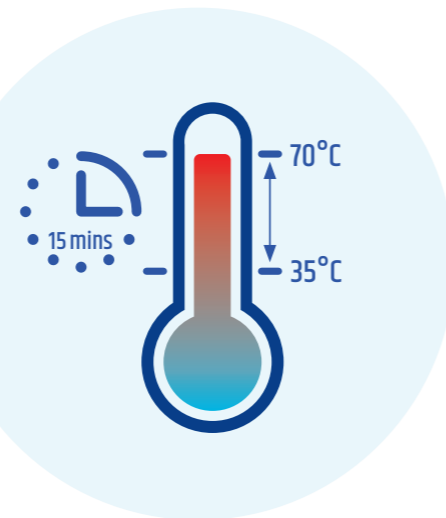

## KEY FEATURES

### Advanced Control System

- True colour, 7" wide screen WVGA Screen user control interface, using the latest version of our highly intuitive operating software.
- 480p (0.38 megapixel) high resolution icon based interface available in multiple languages for ease of understanding and use.

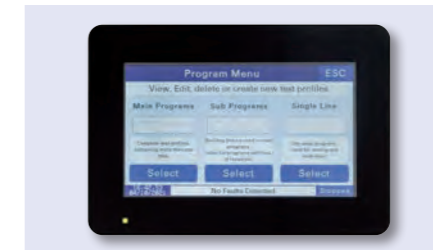

### High velocity vertical air-flow

- Pre-conditioned air from the separate air conditioning unit, is delivered to the chamber and passes vertically and evenly through the test samples, evenly, from top to bottom during the climate controlled testing phase.

- Air flow and uniform distribution, ensures homogeneous distribution of temperature and humidity controlled air throughout the chamber and test samples.

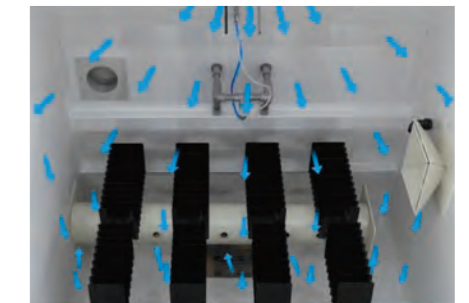

## PERFORMANCE

- **Wetting Mode**  
**Temperature range** - Adjustable from ambient to +70°C/+158°F.  
**Humidity range** - Fixed at 95% - 100% RH.
- **Oscillating Salt Spray Mode**  
**Temperature range** - Adjustable from ambient to +60°C/+140°F.  
**Salt spray fall-out rates** - Adjustable from 5 to 10 Ltrs/m<sup>2</sup> per hour.
- **Dual Atomiser Salt Spray Mode**  
**Temperature range** - Adjustable from ambient to +60°C/+140°F.  
**Salt spray fall-out rates** - Adjustable from 0.5 to 5.5ml per 80cm<sup>2</sup> per hour.
- **Forced Air Drying Mode**  
**Temperature range** - Adjustable from ambient to +80°C/+176°F.
- **Ambient Air Drying Mode**  
**Temperature/humidity range** - Alters to laboratory ambient conditions.
- **Climatic Mode**  
**Temperature/humidity range** - See graph.
- **Controlled Temperature Only Mode**  
**Adjustable from ambient to +60°C/+140°F.**

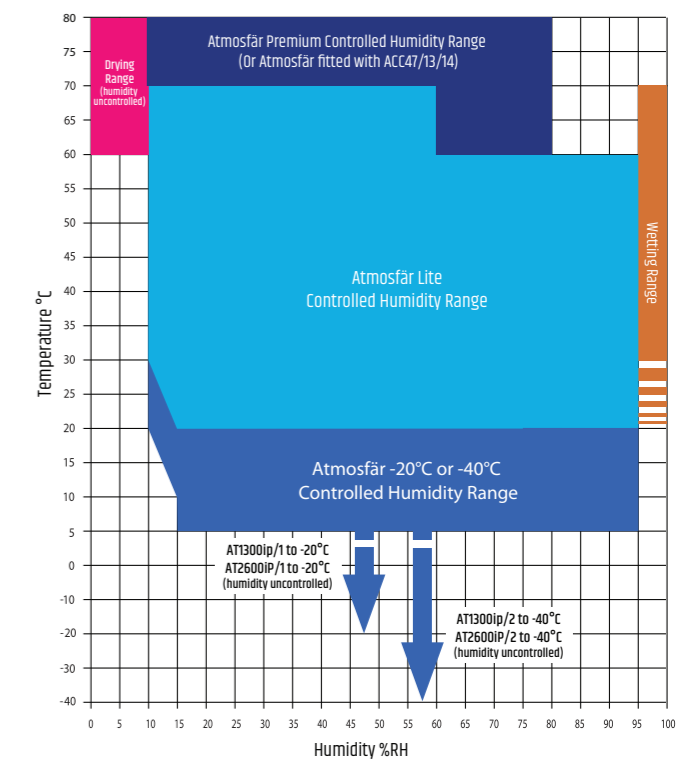

# Atmosfär Premium Specifications

| Atmosfär Premium test chambers                  | Atmosfär Premium Lite<br>• AT1300IP/10   | Atmosfär Premium -20°C<br>• AT1300IP/8<br>• AT1300IP/11   | Atmosfär Premium -40°C<br>• AT1300IP/9<br>• AT1300IP/12 | Atmosfär Premium Lite<br>• AT2600IP/10             | Atmosfär Premium -20°C<br>• AT2600IP/8<br>• AT2600IP/11   | Atmosfär Premium -40°C<br>• AT2600IP/9<br>• AT2600IP/12 |
|---|--|---|---|--|---|---|
| Minimum controlled temperature                  | 20°C/68°F  | -20°C / -4°F  | -40°C / -40°F   | 20°C/68°F  | -20°C / -4°F  | -40°C / -40°F   |
| Chamber capacity                                | 1300 Ltrs / 45.9 cu.ft   | 1300 Ltrs / 45.9 cu.ft  | 1300 Ltrs / 45.9 cu.ft                                  | 2600 Ltrs / 91.8 cu.ft                             | 2600 Ltrs / 91.8 cu.ft  | 2600 Ltrs / 91.8 cu.ft                                  |
| Chamber weight                                  | 340 kg   | 340 kg  | 340 kg  | 440 kg   | 440 kg  | 440 kg  |
| Mounting format                                 | Floor standing   | Floor standing  | Floor standing  | Floor standing                                     | Floor standing  | Floor standing  |
| Loading threshold                               | 800mm / 31.5"  | 800mm / 31.5"   | 800mm / 31.5"   | 800mm / 31.5"                                      | 800mm / 31.5"   | 800mm / 31.5"   |
| Chamber external dimensions                     | W<br>D<br>H  | 2025mm / 80.0"<br>1316mm / 51.8"<br>1965mm / 77.4"  | 2025mm / 80.0"<br>1316mm / 51.8"<br>1965mm / 77.4"      | 2025mm / 80.0"<br>1316mm / 51.8"<br>1965mm / 77.4" | 2885mm / 113.6"<br>1316mm / 51.8"<br>1965mm / 77.4"   | 2885mm / 113.6"<br>1316mm / 51.8"<br>1965mm / 77.4"     |
| Chamber internal dimensions                     | W<br>D<br>H  | 1300mm / 51.2"<br>980mm / 38.5"<br>1500mm / 59.0"   | 1300mm / 51.2"<br>980mm / 38.5"<br>1500mm / 59.0"       | 1300mm / 51.2"<br>980mm / 38.5"<br>1500mm / 59.0"  | 2160mm / 85.0"<br>980mm / 38.5"<br>1500mm / 59.0"   | 2160mm / 85.0"<br>980mm / 38.5"<br>1500mm / 59.0"       |
| Refrigeration unit                              | W<br>D<br>H  | 650mm / 25.6"<br>1350mm / 53.1"<br>1070mm / 42.1"   | 1125mm / 44.3"<br>1354mm / 53.3"<br>1624mm / 63.9"      | 1125mm / 44.3"<br>1354mm / 53.3"<br>1624mm / 63.9" | 650mm / 25.6"<br>1350mm / 53.1"<br>1070mm / 42.1"   | 1125mm / 44.3"<br>1354mm / 53.3"<br>1624mm / 63.9"      |
| Salt solution reservoir<br>90 Ltrs/23 US gal    | W<br>D<br>H  | 540mm / 21.2"<br>540mm / 21.2"<br>635mm / 25"   | 540mm / 21.2"<br>540mm / 21.2"<br>635mm / 25"           | 540mm / 21.2"<br>540mm / 21.2"<br>635mm / 25"      | 540mm / 21.2"<br>540mm / 21.2"<br>635mm / 25"   | 540mm / 21.2"<br>540mm / 21.2"<br>635mm / 25"           |
|   |  | Separate unit, one supplied to deliver salt water to the conventional salt spray atomizer                         |   |  |   |   |
| Salt solution reservoir<br>160 Ltrs/42.2 US gal | W<br>D<br>H  | 840mm / 34.0"<br>500mm / 19.7"<br>790mm / 31.1"   | 840mm / 34.0"<br>500mm / 19.7"<br>790mm / 31.1"         | 840mm / 34.0"<br>500mm / 19.7"<br>790mm / 31.1"    | 840mm / 34.0"<br>500mm / 19.7"<br>790mm / 31.1"   | 840mm / 34.0"<br>500mm / 19.7"<br>790mm / 31.1"         |
|   |  | Separate unit, one supplied to deliver salt water to the oscillating spray bar                                    |   |  |   |   |
| Chamber construction                            | Glass reinforced plastic, Polypropylene & ABS parts  |   |   |  |   |   |
| Colour  | 9 standard colours to choose from free of charge   |   |   |  |   |   |
| Electricity supply                              | One 3-phase electrical supply  | Two 3-phase electrical supplies are required (one for the chamber and one for the separate air conditioning unit) |   | One 3-phase electrical supply                      | Two 3-phase electrical supplies are required (one for the chamber and one for the separate air conditioning unit) |   |
|   | The voltage (VAC) and frequency (Hz) are dependent on country/region of installation (to be confirmed at the time of ordering)   |   |   |  |   |   |
| Water   | The air saturator, humidity generator and salt solution reservoir all require separate connections to a continuous, pressurized deionized/distilled water supply of 4.0 - 5.0 bar (58-72psi)                 |   |   |  |   |   |
| Air   | Clean dry & oil free compressed air, 4.0 to 6.0 bar (58-87psi) with 240 Ltrs (8.5cu.ft) per minute flow. Two separate supplies are required, one for the chamber and one for the separate refrigeration unit |   |   |  |   |   |
| Exhaust   | 3m (10ft) exhaust pipe is required which should be terminated outside building (see accessory ACC58)   |   |   |  |   |   |
| Drain   | 3m (10ft) drain pipe is required which should be terminated into floor level drain (see accessory ACC58)   |   |   |  |   |   |
| Operating environment conditions                | Indoors, with ambient maintained at +18 to +23°C (+64 to 73°F), 85% max RH (non-condensing)  |   |   |  |   |   |

# Automotive/OEM Test Standards

Below, the most popular Automotive/OEM test standards have been grouped (by the refrigeration capacity required) so that the most appropriate model of Atmosfär Premium chamber can be selected for compliance:

| Atmosfär Premium Lite<br>• AT1300IP/10<br>• AT2600IP/10 | Atmosfär Premium -20°C<br>• AT1300IP/8<br>• AT2600IP/8<br>• AT1300IP/11<br>• AT2600IP/11 | Atmosfär Premium -40°C<br>• AT1300IP/9<br>• AT1300IP/12<br>• AT2600IP/9<br>• AT2600IP/12 |
|---|--|--|
| CCT-1   | CCT-1  | CCT-1  |
| CCT-2   | CCT-2  | CCT-2  |
| CCT-4   | CCT-4  | CCT-4  |
| JASO M-609 / M-610                                      | JASO M-609 / M-610   | JASO M-609 / M-610   |
| FORD CEPT 00.00-L-467                                   | FORD CEPT 00.00-L-467  | FORD CEPT 00.00-L-467  |
| IEC 60068-2-52 (All methods)                            | IEC 60068-2-52 (All methods)   | IEC 60068-2-52 (All methods)   |
| Renault D17 2028 (ECC-1)                                | Renault D17 2028 (ECC-1)   | Renault D17 2028 (ECC-1)   |
| RNES - G -00005 / 0006 / 0007                           | RNES - G -00005 / 0006 / 0007  | RNES - G -00005 / 0006 / 0007  |
| SAE J 2334 (Method C)                                   | SAE J 2334 (Method C)  | SAE J 2334 (Method C)  |
| Toyota 1555G (Method C)                                 | Toyota 1555G (Method C)  | Toyota 1555G (Method C)  |
| Volvo VCS 1027,149 (ACT-1)                              | Volvo VCS 1027,149 (ACT-1)   | Volvo VCS 1027,149 (ACT-1)   |
| Volvo VCS 1027,1449 (ACT-2)                             | Volvo VCS 1027,1449 (ACT-2)  | Volvo VCS 1027,1449 (ACT-2)  |
| TP-JLR-52.265   | TP-JLR-52.265  | TP-JLR-52.265  |
| GMW14872  | GMW14872   | GMW14872   |
| SCANIA STD4319  | SCANIA STD4319   | SCANIA STD4319   |
| VW PV 1210  | VW PV 1210   | VW PV 1210   |
| Hyundai/Kia CCT-A                                       | Hyundai/Kia CCT-A  | Hyundai/Kia CCT-A  |
| Honda 5100Z Simple Mode                                 | Honda 5100Z Simple Mode  | Honda 5100Z Simple Mode  |
| ISO 6270-2  | ISO 6270-2   | ISO 6270-2   |
| ISO 11997 Cycle A, B & D                                | ISO 11997 Cycle A, B & D   | ISO 11997 Cycle A, B & D   |
|   | VDA 233-102  | VDA 233-102  |
|   | Honda 5100Z Basic Mode   | Honda 5100Z Basic Mode   |
|   | Hyundai/Kia CCT-B  | Hyundai/Kia CCT-B  |
|   | DIN 55635  | DIN 55635  |
|   |  | VW PV 1200   |
|   |  | VW PV 1209   |

# Kesternich Test Chambers

To find the right chamber for your test requirements visit [www.ascott-analytical.com](http://www.ascott-analytical.com)

**KH300 – Fully Automatic SO2 Gas Dosing Test Chamber fully complies with:**

- ASTM D2247
- EN ISO 6988 SFW 2,0,5
- KTW ISO 3231 DIN 50018
- S02 Humidity mode.
- ISO 11503
- ISO EN 1096 B
- VDA 621-421
- Condensation Humidity mode.
- NFT 30-055
- ISO 22479 DIN 50017 KK
- ISO EN 1096 C
- Air Flushing mode.
- ASTM G87 BS3900/F9 ISO 6270-2 CH
- Fully automated electronic gas dosing system.
- Hermetically sealed chamber for safety.
- Automatic drain and exhaust system.
- Digital precision temperature control.
- Temperature graphical display.
- Interior viewing window.
- Interior illumination.
- Also available in desk top version.

Kesternich testing simulates acid rain or industrial chemical exposure to evaluate the relative corrosion resistance of the coating, substrate, or part itself. Parts or panels are placed inside a specially designed chamber and are exposed to SO2 and condensation humidity before being evaluated for resistance to corrosion.

A specific volume of SO2 gas, usually 0.2L, 1L or 2L is introduced into the test chamber, the chamber temperature is increased to a predetermined level and the relative humidity is maintained at condensation levels. After a set period, the chamber is vented and the temperature is allowed to decrease to ambient conditions.

Ascott's Kesternich chamber does not require any human intervention whilst running the tests, its fully automatic design is controlled by a state of the art control system. The Kesternich chamber is designed to meet various gas dosing test standards as listed above and can also be used as a condensation humidity chamber.



## KEY FEATURES

- 'Easy Open' pneumatically operated canopy.
- Dry seal gasket prevents wetting operator's clothes, etc.
- Low loading threshold for loading and unloading.
- Canopy colour choice free of charge.
- True colour, 7" wide screen WVGA Screen user control interface, using the latest version of our highly intuitive operating software.
- 480p (0.38 megapixel) high resolution icon based interface available in multiple languages for ease of understanding and use.

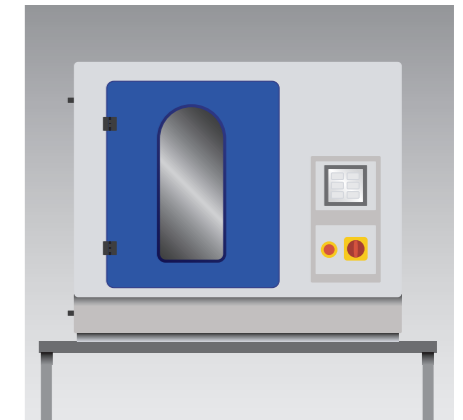

KH300TT Desktop Kesternich Chamber

## OPTIONAL ACCESSORIES

- Data Logging Software.
- Various sample racks available.
- Personal SO2 Detector.
- Wall Mounted SO2 Detector.



Data Logging Software



SO2 dispersion bar



SO2 Detector

## SPECIFICATIONS

- **Floor Standing External Dimensions:** 1478 x 769 x 2010mm / 58 x 30 x 80"
- **Desktop External Dimensions:** 1478 x 769 x 1318mm / 58 x 30 x 52"  
Angled interior roof avoids droplets falling onto samples
- **Volume:** 300 Ltrs/10.5cu.ft
- **Temperature Range:** Ambient to +50°C/+122°F
- **Temperature Stability:** +/- 0.75°C
- **Power Supply:** 220-240V, Single Phase 50Hz



Inside the KH300 Chamber



KH300 Control panel and window canopy



Automatic SO2 Dosing System

# CorroFlex Test Chambers

## Flexible front loading chambers for testing large/heavy samples.

In response to customer demand for larger test chambers to test large samples, in a wide variety of shapes, sizes and weights, Ascott manufacture the CorroFlex, flexible size corrosion chamber.

These chambers all feature the convenience of a front loading door, which fully opens and closes at the push of a button, giving unimpeded

access to the chamber interior. The door slides up to close and down to open, minimising the floor space required when installed.

CorroFlex corrosion test chambers offer the user flexibility in specifying the perfect size of chamber to suit their application. The width and depth dimensions are variable and can be selected in 0.5m increments.



Mesh racking

## The CorroFlex range of front loading corrosion chambers are available in three model specifications:

### CFS

CFS models are salt spray only test chambers and can perform single temperature, continuous salt spray tests in accordance with international standards such as: ASTM B117, ISO 9227, JIS Z 2371 and many more.

### CFSP

CFSP models are Premium salt spray chambers and can perform the same basic salt spray tests as Standard models, but in addition are equipped with extra features enable them to undertake 'modified' tests such as ASTM G85. Here conventional salt spray is usually combined with one other climate, in a two-part cycle.

### CFX

CFX models are cyclic corrosion chambers and can be programmed to create any of 6 distinct climates: salt spray, controlled humidity, forced air drying, condensation humidity, temperature only control and ambient air drying mode. These climates can be programmed to occur in any sequence for any period of time and repeat automatically.

## FEATURES (ALL MODELS)

### Advanced Control System

- Front loading system for ease of loading large/ heavy test samples in a wide range of shapes and sizes.
- High strength GRP panel front door available in 9 standard colours with windows for viewing samples during testing.
- Pneumatically operated door for ease of opening and closing (door slides up to close and down to open).
- Interior illumination fitted as standard.
- High load capacity mesh racking supplied as standard.
- Large external, portable salt solution tank with wheels, for ease of access to a water source, and an integral drain system for ease of cleaning.
- Exterior shell is fully resistant to corrosion.

## CFS PERFORMANCE

- **Salt Spray Mode** - Adjustable from ambient to +50°C/+122°F.<sup>1</sup>
- **Salt Spray Fall-out Rates** - Adjustable from 0.5 to 2 ml per 80 cm<sup>2</sup> per hour.

## CFSP PERFORMANCE

- **Salt Spray Mode** - Adjustable from ambient to +50°C/+122°F.<sup>1</sup>
- **Salt Spray Fall-out Rates** - Adjustable from 0.5 to 2 ml per 80 cm<sup>2</sup> per hour.
- **Wetting Mode** - Adjustable from ambient to +50°C/+122°F.
- **Forced Air Drying Mode** - Adjustable from ambient to +50°C/+122°F.
- **Controlled Temperature Only Mode** - Adjustable from ambient to +50°C/+122°F.
- **Ambient Air Drying Mode** - Chamber canopy can be programmed to open and close at any point during a test

## CFX PERFORMANCE

- **Salt Spray Mode**  
Temperature range - Adjustable from ambient to +60°C/+140°F.  
Salt spray fall-out rates - Adjustable from 0.5 to 2 ml per 80 cm<sup>2</sup> per hour.\*
- **Wetting Mode**  
Temperature range - Adjustable from ambient to +70°C/+158°F.  
Humidity range - Fixed at 95% - 100% RH.
- **Forced Air Drying Mode**  
Temperature range - Adjustable from ambient to +70°C/+158°F.
- **Controlled Humidity Mode**  
Temperature/humidity range - Details on request.
- **Controlled Temperature Only Mode**  
Adjustable from ambient to +50°C/+122°F.
- **Ambient Air Drying Mode**  
Chamber canopy can be programmed to slide open and close at any point during a test.

## CORROFLEX SPECIFICATIONS

The CorroFlex range of front loading corrosion chambers are available in three model specifications.

|                  |                    | Internal Width (mm) | Internal Depth (mm) | Internal Apex Height (mm) | Capacity (Litres) | Capacity (Metres <sup>3</sup> ) | External Width (mm) | External Depth (mm) | External Height (mm) | Door Width (mm) | Door Height (mm) |
|------------------|--------------------|---------------------|---------------------|---------------------------|-------------------|---------------------------------|---------------------|---------------------|----------------------|-----------------|------------------|
| 1m Deep System   | CFX/CFSP/CFS 1600  | 1500                | 1000                | 1245                      | 1600              | 1.6                             | 2834                | 1300                | 2237                 | 1290            | 791              |
|                  | CFX/CFSP/CFS 2200  | 2000                | 1000                | 1245                      | 2200              | 2.2                             | 3331                | 1300                | 2237                 | 1790            | 791              |
|                  | CFX/CFSP/CFS 2700  | 2500                | 1000                | 1245                      | 2700              | 2.7                             | 3828                | 1300                | 2237                 | 2290            | 791              |
|                  | CFX/CFSP/CFS 3300  | 3000                | 1000                | 1245                      | 3300              | 3.3                             | 4325                | 1300                | 2237                 | 2790            | 791              |
|                  | CFX/CFSP/CFS 3800  | 3500                | 1000                | 1245                      | 3800              | 3.8                             | 4822                | 1300                | 2237                 | 3290            | 791              |
|                  | CFX/CFSP/CFS 4400  | 4000                | 1000                | 1245                      | 4400              | 4.4                             | 5319                | 1300                | 2237                 | 3790            | 791              |
| 1.5m Deep System |                    | Internal Width (mm) | Internal Depth (mm) | Internal Apex Height (mm) | Capacity (Litres) | Capacity (Metres <sup>3</sup> ) | External Width (mm) | External Depth (mm) | External Height (mm) | Door Width (mm) | Door Height (mm) |
|                  | CFX/CFSP/CFS 2400+ | 1500                | 1500                | 1280                      | 2400              | 2.4                             | 2834                | 1800                | 2237                 | 1290            | 791              |
|                  | CFX/CFSP/CFS 3200+ | 2000                | 1500                | 1280                      | 3200              | 3.2                             | 3331                | 1800                | 2237                 | 1790            | 791              |
|                  | CFX/CFSP/CFS 4000+ | 2500                | 1500                | 1280                      | 4000              | 4.0                             | 3828                | 1800                | 2237                 | 2290            | 791              |
|                  | CFX/CFSP/CFS 4800+ | 3000                | 1500                | 1280                      | 4800              | 4.8                             | 4325                | 1800                | 2237                 | 2790            | 791              |
|                  | CFX/CFSP/CFS 5600+ | 3500                | 1500                | 1280                      | 5600              | 5.6                             | 4822                | 1800                | 2237                 | 3290            | 791              |
|                  | CFX/CFSP/CFS 6400+ | 4000                | 1500                | 1280                      | 6400              | 6.4                             | 5319                | 1800                | 2237                 | 3790            | 791              |

<sup>1</sup>Option ACC03 increases temperature range up to +60°C / +140°F.

\*Option ACC01 or ACC25 increases the fallout rate up to 5.5ml per 80cm<sup>2</sup> per hour.

Local representative/supplier:

#### Ascott Worldwide

Ascott are represented worldwide by a network of authorized distributors/agents, who have been fully trained in all aspects of our products, including technical support and maintenance.

Please contact us for further details.

#### European Office

Ascott Analytical Equipment Limited, 6-8 Gerard, Lichfield Road Industrial Estate, Tamworth, Staffordshire, B79 7UW, Great Britain.

**T** +44 (0) 1827 318040

**F** +44 (0) 1827 318049

**E** [sales@ascott-analytical.com](mailto:sales@ascott-analytical.com)

**W** [www.ascott-analytical.com](http://www.ascott-analytical.com)



All Ascott chambers are **CE** marked.

Prohesion™ is a trademark of Croda Mebon Ltd.

Sikkens™ is a trademark of Akzo Nobel Coatings International B.V.

Mag-Drive™ is a trademark of Ascott Analytical Equipment Ltd.

Mag-Drive is patented technology of Ascott Analytical Equipment Ltd.

It is the policy of Ascott Analytical Equipment Ltd to protect its products by means of patents, registered trademarks and registered designs.

The information contained herein was correct at time of going to press and is subject to change without notice.

© 2022 Ascott Analytical Equipment Ltd.

**ascott**  
Testing climate resistance to the limit

Corrosion Testing Equipment & Accessories